



# Spectra Precision Laser DG613/DG813



User Guide

DG813



DG613



SF803



RC803



# **TABLE OF CONTENTS**

**Introduction**

**For Your Safety**

**Laser**

**How to Use the Laser System**

**Powering the Laser**

**Turning On/Off the laser**

**Features and Functions**

**Laser Setup**

**Turning On/Off the laser**

**Standard Display Laser and RC803**

**RC803 Radio/IR Remote Control**

**Powering the RC803**

**Turning On/Off the Radio/IR Remote Control**

**Pairing the RC803 with the DG813/DG613**

**Components SpotFinder SF803**

**Powering the SF803**

**SF803 - Features and Functions**

**Pairing the Spot Finder SF803 with the DG813**

**Menu Functions**

**Entering Grade**

**Automatic Spot Align (DG813)**

**Automatic Spot Match (DG813)**

**Automatic SpotLok (DG813)**

**Manual Spot Search (DG813)**

**Line Scan**

**Line Set/Check**

**Start Reference Check**

**Standby Mode**

**Settings**

**Info**

**Service**

**Setting menu details**

**Grade Entry**

**Grade Display**

**Sensitivity Selection**

**User Name**

**Set Password**

**Password On/Off**

**Radio Channel**

**Select Language**

**Position Info**

**Calibration**

**PROTECTING THE UNIT**

**CLEANING AND MAINTENANCE**

**PROTECTING THE ENVIRONMENT**

**TECHNICAL DATA**

**DECLARATION OF CONFORMITY**

## Introduction

Thank you for choosing one of the Spectra Precision Lasers from the Trimble family of precision pipe lasers. The pipe laser is an easy-to-use tool that provides underground contractors line, elevation, and grade control for installing storm, sanitary, or other gravity-flow pipe. This system can also be used for tunneling, boring, pipe alignment, or any other application requiring line, elevation, and grade control.

The pipe laser projects a highly visible laser beam in a direction at a predetermined (grade) for the alignment of gravity-flow pipe. The laser light is intercepted by a target. To align the pipe, you need to position it so that the pipe laser's beam is centered at the target's bullseye.

## For Your Safety

For hazardless and safe operation, read all the user guide instructions.



- Use of this product by people other than those trained on this product may result in exposure to hazardous laser light.
- Do not remove warning labels from the unit.
- The DG813/DG613 are class 3A/3R laser (<5mW; 600 – 680nm) IEC 60825-1:2007). Class 2 version are also available.
- **Never** look into the laser beam or direct it to the eyes of other people.
- Always operate the unit in a way that prevents the beam from getting into people's eyes.
- If initial service is required, which results in the removal of the outer protective cover, removal must only be performed by factory-trained personnel.



**Caution:** Use of other than the described user and calibration tools or other procedures may result in exposure to hazardous laser light.

**Caution:** Using different than described at the pipe laser user guide, may result in unsafe operation.

## Features and Functions

### Laser

- 1 Battery Compartment
- 2 Battery Door Latches
- 3 LCD Graphic Display
- 4 Grade Axis Pivot Marker
- 5 Line-Axis Pivot Marker and LED
- 6 Handle
- 7 Axis Alignment Markers
- 8 Mounts for scope adapter
- 9 5/8"-11 Threaded Mount
- 10 Remote Receiver Window
- 11 Beam-Exit Window
- 12 Power Button
- 13 M - Menu Button
- 14 E - Enter Button
- 15 Escape/Lock Button
- 16 Left Line Control Button
- 17 Plus Button
- 18 Minus Button
- 19 Right Line Control Button

## How to Use the Laser System

### Batteries

#### WARNING

Ni-MH batteries may contain small amounts of harmful substances.

Be sure to charge the battery before using it for the first time, and after not using it for an extended length of time.

Charge only with specified chargers according to device manufacturer's instructions.

Do not open the battery, dispose of in fire or short circuit; it may ignite, explode, leak or get hot causing personal injury.

Dispose in accordance with all applicable federal, state, and local regulations.

Keep the battery away from children. If swallowed, do not induce vomiting. Seek medical attention immediately.

## Powering the Laser

### Recharging the Batteries

The laser is shipped with a rechargeable Ni-MH battery pack, it is keyed to prevent mis-insertion.

**Note:** The approximate charge of the batteries is shown at the top of the LCD when pressing the **E** button.

The charger requires approx. 10 hours to charge completely discharged batteries.

For charging, connect the plug of the charger to the recharge jack of the battery pack.

New or long-time out-of-use rechargeable batteries reach their best performance after being charged and recharged five times. Alkaline batteries can be used as a backup. Insert 4 D-cell batteries noting the plus (+) and minus (-) diagrams inside the battery housing.

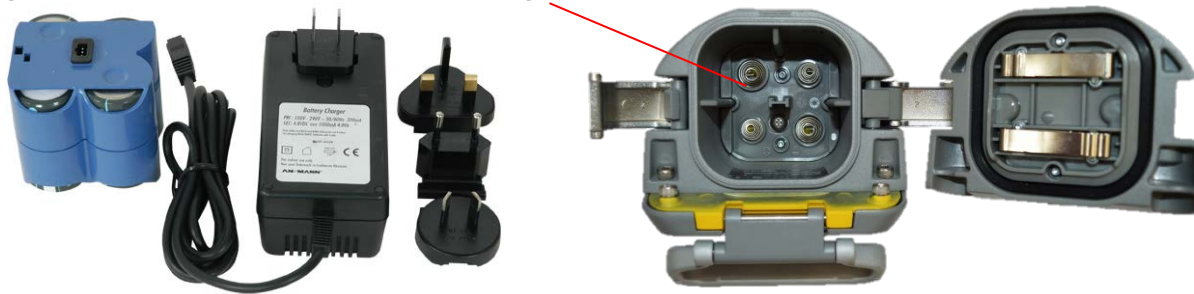

The batteries should only be charged when the laser is between 50°F and 104° F (10°C to 40°C). Charging at a higher temperature may damage the batteries. Charging at a lower temperature may increase the charge time and decrease the charge capacity, resulting in loss of performance and shortened life expectancy.

### Installing Batteries

Open the battery door by pulling out the door latches. Insert batteries (or a rechargeable battery pack) into the housing so that the **negative poles are on the bigger battery spiral springs**.

Close the battery door and lock it by pushing the door latches back to the housing.

Only the original rechargeable battery pack allows charging with the provided charger.



# Features and Functions

1. **Battery Compartment** – holds the NiMH battery pack. (D-Cell alkaline batteries can be used as a backup.)

2. **Battery Door Latches** – locks/unlocks and holds the battery compartment in place.

3. **LCD Graphic Display** - shows the power, grade, battery, out-of-level, beam position and status of the laser.

4. **Grade Axis Pivot Marker** - identifies the pivot point for the grade system

5. **Line-Axis Pivot Marker and LED** - used to align a transit over the top of the laser; lights for 15 minutes after turning on the laser or pressing one of the buttons.

6. **Handle** - to carry the laser easily and to attach a safety rope in manholes with water.

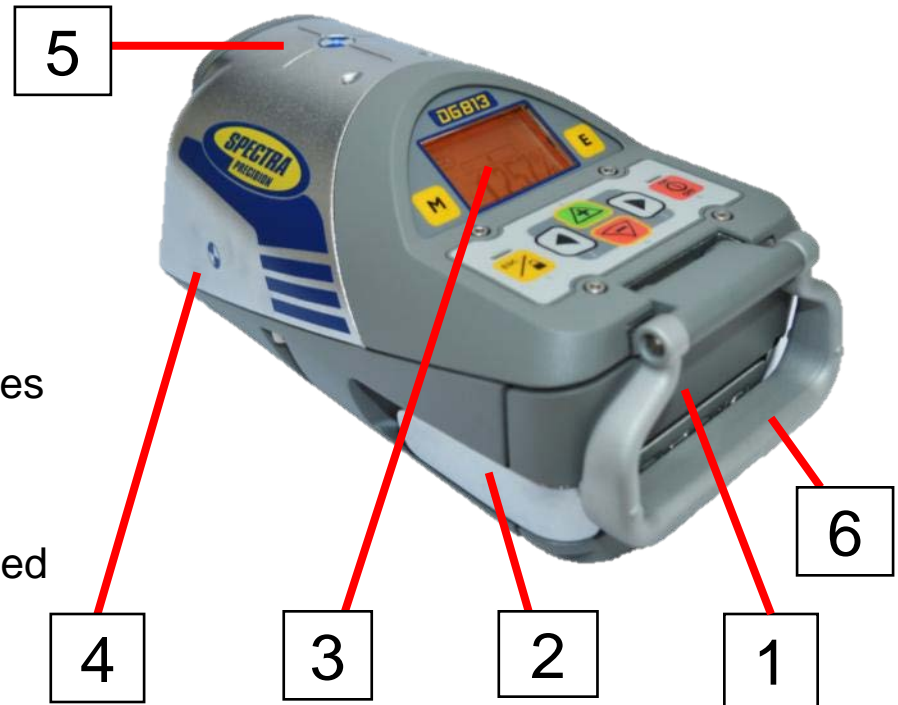



## Features and Functions

**7. Axis Alignment Markers** - used to align the laser when the line system is centered.

**8. Mounts for scope adapter** – to attach the optional scope adapter for the „Over the Top“ application

**9. 5/8”-11 Threaded Mount** – to attach the laser to various setup accessories

**10. Remote Receiver Window** – receives signals from the RC803 and SF803

**11. Beam-Exit Window** – provides a clear window for the laser beam to exit the pipe laser.

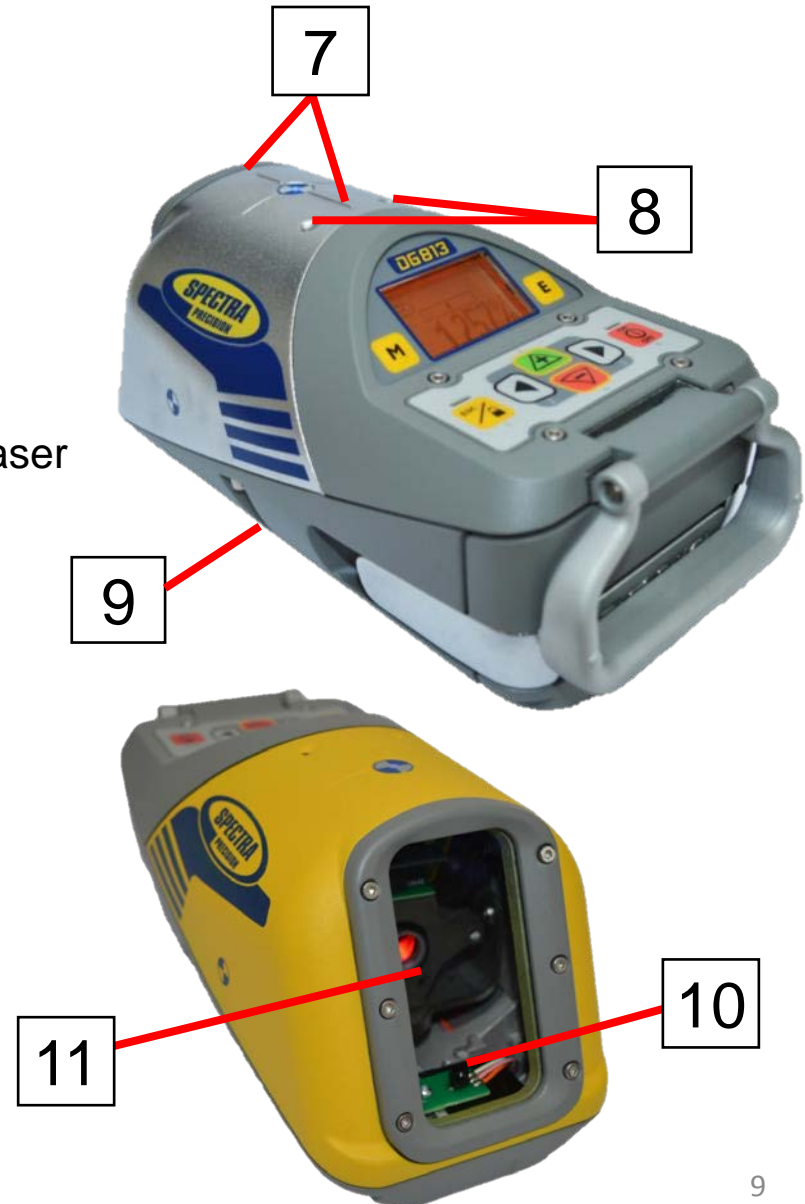

# Features and Functions

- 12. Power Button** - turns the laser On/Off  
(To turn off the laser, press and hold the button for 2 seconds).
- 13. M – Menu Button** - Quickly press and release starts the menu entry. Use the 2 to 5 buttons to toggle through the menu.
- 14. E - Enter Button** - Quickly press and release to activate a selected menu function and show the actual laser and remote control battery status.
- 15. Escape/Lock (EL) Button** - (If pressed simultaneously with one of the left/right or +/- buttons, it locks/unlocks the +/- or the left/right buttons, so that the unit can't be unintentionally changed. If pressed for 5 seconds, the unit switches to the manual mode (steep grade).

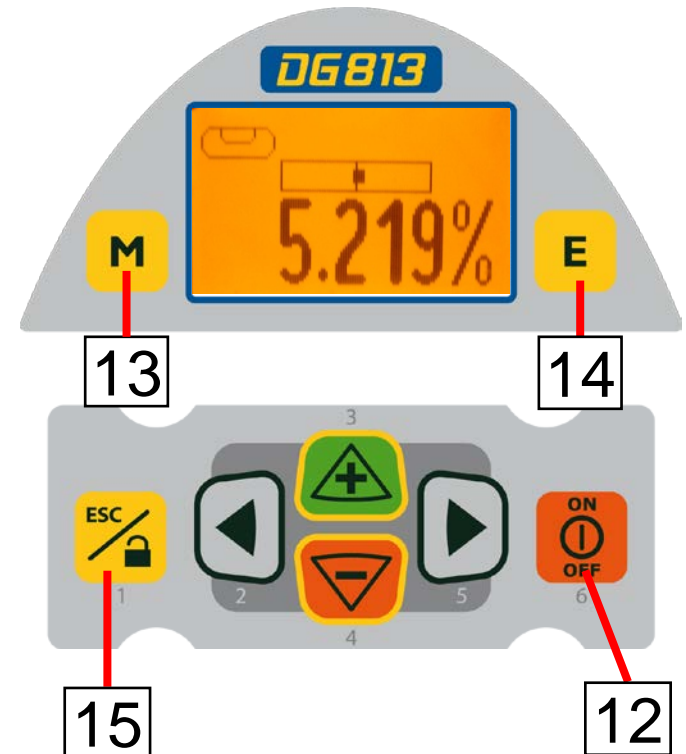
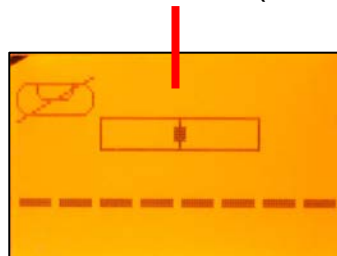

# Features and Functions

**16. Left Line Control Button** - moves the laser beam to the left. (Simultaneously pressed with the Right Line Button, centers the line.)

**17. Plus Button** - increases the grade.

**18. Minus Button** - decreases the grade.

**19. Right Line Control Button** - moves the laser beam to the right. (Simultaneously pressed with the Left Line Button, centers the line.)

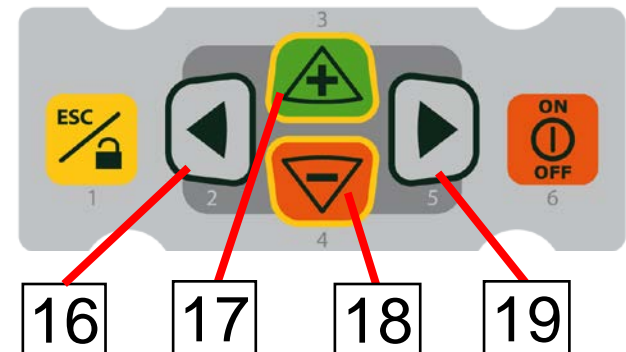
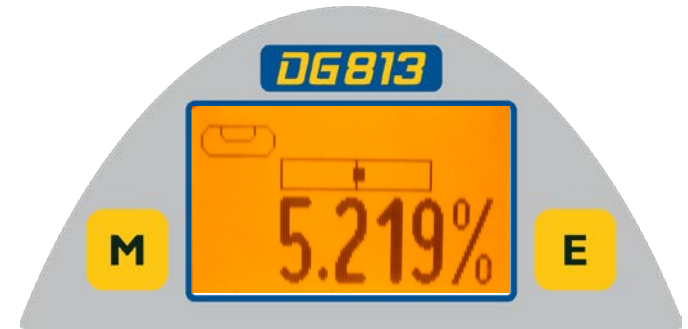

## Laser Setup

Position the laser at the manhole invert or on bottom of the trench at the desired elevation.

### Turning On/Off the laser

Press the power button to turn On the laser; the LCD shows **Initialization** for one second (red and green LEDs are on - diagnostic mode).

The unit starts the temperature/reference check while the **thermometer symbol** is flashing.

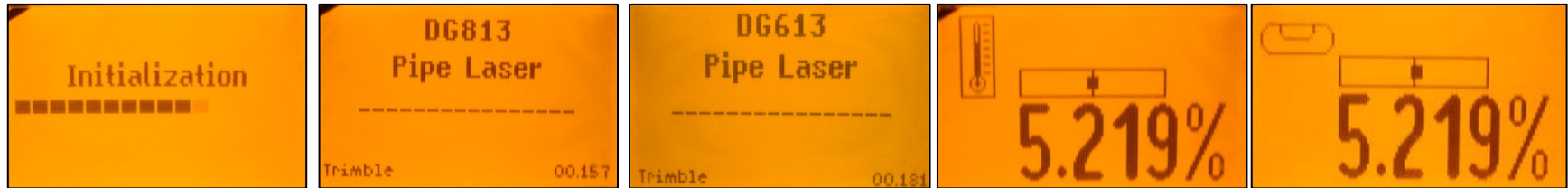

**Don't start automatic functions at the menu before the reference check has been finished.**

**If an automatic function will be selected and then confirmed with the E button during the reference check, the display shows the reference check is still running.**



The standard display turns on and the self-leveling will start at once.

The unit is leveled when the laser beam is no longer flashing (once every second).

To turn Off the laser, press and hold the power button for two seconds.

If the laser is positioned beyond its self-leveling range of -12 to + 40%, the laser beam remains flashing.

Reposition the laser within its self-leveling range. The laser's cross axis is completely compensated over the entire roll range. Once leveled, the unit constantly monitors its level condition. Depending on the selection at settings, the setup control (Line alert) is activated 5 minutes or 30 seconds after self-leveling was performed. If Line Alert condition comes Off, the beam (+LEDs) flashes two times, pauses for 2 seconds and flashes again two times. After deleting the Line Alert by pressing the **E** button, check the beam's correct position using the target at the last pipe which was led before the Line alert came off.

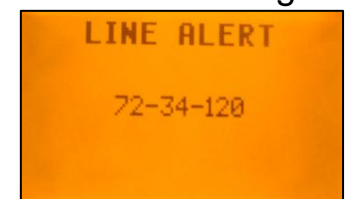

# Features and Functions

## Standard Display Laser and RC803

The remote control mirrors the functionality of the pipe laser keypad

### Automatic mode

+/- buttons locked

line buttons locked

Beam position at SF803

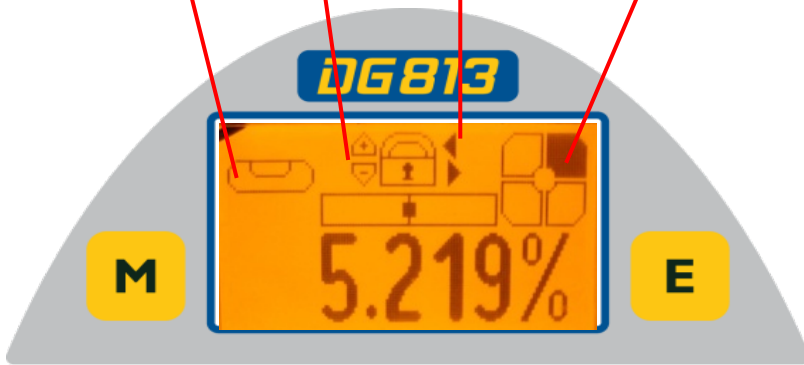

Beam line position related to the housing  
actual grade value

- 1 - Escape/Lock Button
- 2 - Left Line Control Button
- 3 - Plus Button
- 4 - Minus Button
- 5 - Right Line Control Button
- 6 - Power Button
- M - Menu Button
- E - Enter Button
- Hole for hand loop



## RC803 Radio/IR Remote Control

### Powering the RC803

1. Open the battery door using a coin or similar pry device to release the battery door tab on the RC803. RC803 will be shipped with alkaline batteries. Rechargeable batteries can be used optional but need to be charged externally.
2. Insert two AA batteries noting the plus (+) and minus (-) diagrams inside the battery housing.
3. Close the battery door. Push down until it “clicks” into the locked position.



### Turning On/Off the Radio/IR Remote Control

The Radio/IR remote control is a hand-held device that allows you to send operational commands to the laser from a remote location.

Press the power button to turn on the radio/IR remote control.

If the RC803 is outside the radio operating range the remote switches automatically into the IR connection capability.

**Note:** When the remote control is initially turned on, the standard display (model number and software version) appear for the first 3 seconds, then the grade value and line direction indications briefly appear in the LCD.

With every button press, the LCD backlight is activated and turns off automatically if no button is pressed for 8 seconds.

To turn off the radio remote control, press and hold the power button for two seconds.

**Note:** 5 minutes after the last button press, the remote control turns off automatically.

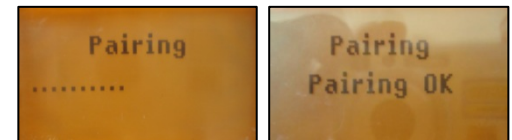

**Pairing the RC803 with the DG813/DG613** - First, make sure the transmitter and the remote control are turned off. Then press and hold the **Escape/Lock (EL)** button and turn on the transmitter. During the next 6 seconds (the red LED flashes fast while the display shows Pairing) repeat the same steps on the remote control. The remote’s display show Pairing OK for one second and then the same function as the laser is actually working to indicate the transmitter has been matched with the remote control.



# Components Spot Finder SF803

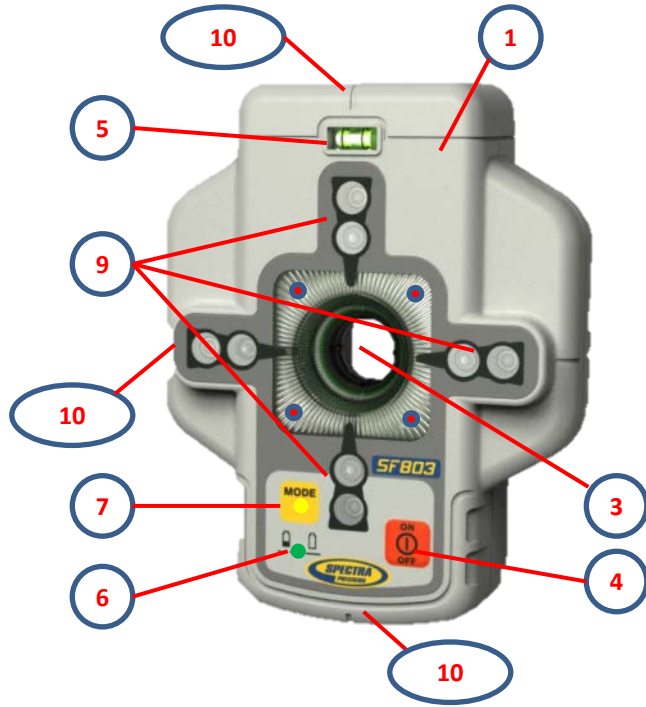

- 1 - SF803
- 2 - Target Plate for Spot Finder
- 3 - Center Hole
- 4 - Power Button
- 5 - Bubble Vial
- 6 - Battery LED
- 7 - Mode LED
- 8 - Red Direction LEDs
- 9 - IR transmitters/receivers
- 10 - Marking notches (front and back)
- 11 - M6 Clamp Mount
- 12 - Battery door
- 13 - Latch for Battery Door
- 14 - Release Tab Target Plate

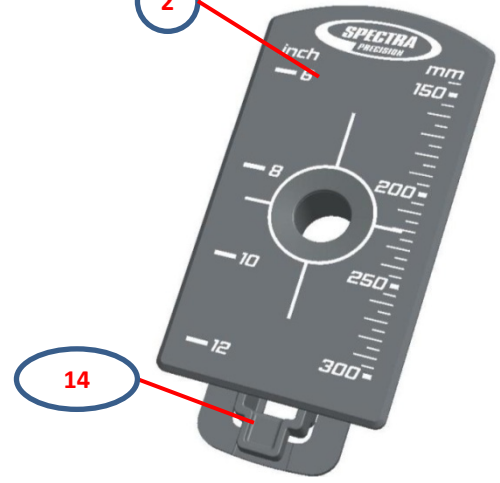
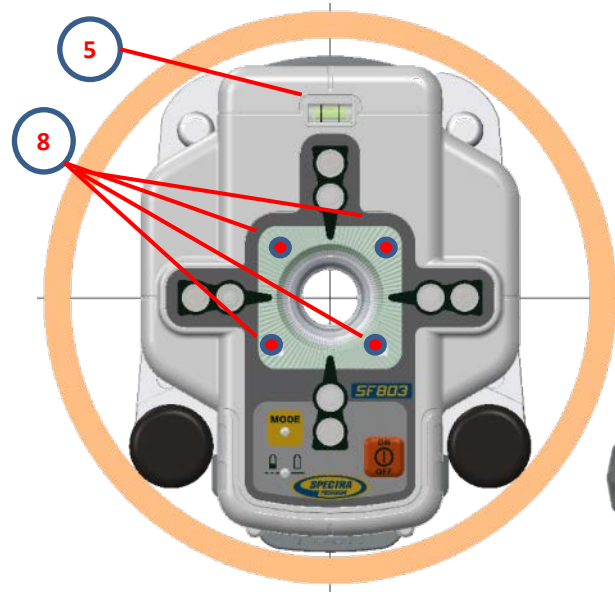



## Powering the SF803

1. Open the battery door pulling the battery door latch.  
The SF803 will be shipped with alkaline batteries.  
Rechargeable batteries can be used optional but need to be charged externally
2. Insert four AA batteries noting the plus (+) and minus (-) diagrams inside on the battery door.
3. Close the battery door. Push down until it “clicks” into the locked position.

## SF803 - Features and Functions

### 1. Power Button:

Press and release the power button to turn ON the SF803.

All display LED's will light for 1.0 sec.

Press and hold power button for >2 sec. to turn OFF the SF803.



### LED's:

#### 2. LED1:

solid green when SF803 is on and battery OK

blinking red if battery voltage is  $3,8V < V_{bat} < 4V$

solid red if battery voltage is  $< 3,8V$ ; SF803 turns off automatically after 5 min.

#### 3. Mode LED2:

yellow solid: radio connection OK / yellow flashing: none or lost radio signal

#### 4. Direction LEDs red:

Manual mode: pointing towards the center of the plumb beam.

All 4 LEDs are solid red when the beam is centered.

Automatic SpotLock mode: solid for 5 min., then LED's flash every 5 seconds.

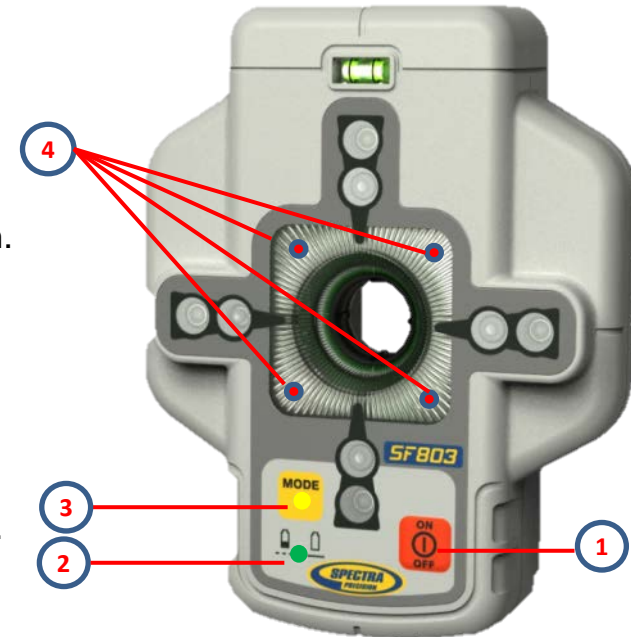

## Pairing the Spot Finder SF803 with the DG813 -

First, make sure the transmitter and the Spot Finder are turned off. Then press and hold the **Escape/Lock** button and turn on the transmitter. Turn On the Spot Finder; the SF803 pairs now automatically with the transmitter.

After a successful pairing, the Laser shows the standard display while the yellow SF803 LED is solid.

## Menu Functions

Press and release **M button** at the Standard Display to enter the MENU.

**The menu offers always only the available features depending which pipe laser (DG813 or DG613) is used.**

The icon of the selected function will be highlighted.

A down arrow at the the right site indicates that the user can scroll down through the menu using the **down** arrow button.

After going to the next menu row, an up/down arrow at the the right site indicates that the user can scroll up/down through the menu using the **+/-** arrows buttons.

Pressing and releasing button **M** changes the unit always back to the standard or previous display.

Press and release the **2 to 5** buttons until the desired function at the selected menu row is marked.

Press and release button **E** to open the submenu OR start the selected function.

### Menu functions available at the DG813

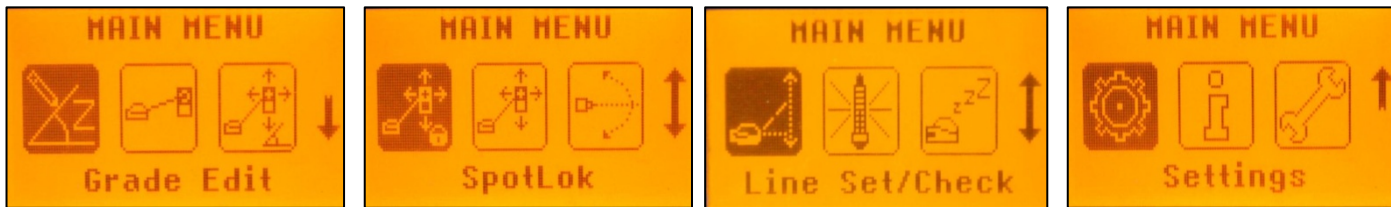

### Menu functions available at the DG613



## Menu Functions (IR controlled)

If the RC803 is paired with a transmitter and the radio connection doesn't work, e.g., through a pipe, the IR connection offers the following functions.

Press and release the **M** button at the Standard Display.

Pressing and releasing button **M** changes the unit always back to the standard or previous display.

Press and release the buttons **2** to **5** until the desired icon is highlighted.

Press and release **E** button start the selected function.

**Note:** If a remote is paired with a transmitter the IR signals of the remote (in case of an interrupted radio connection) will be transmitted in a **private mode** so that only the paired transmitter can receive these IR commands.

### IR-menu functions available at the DG813

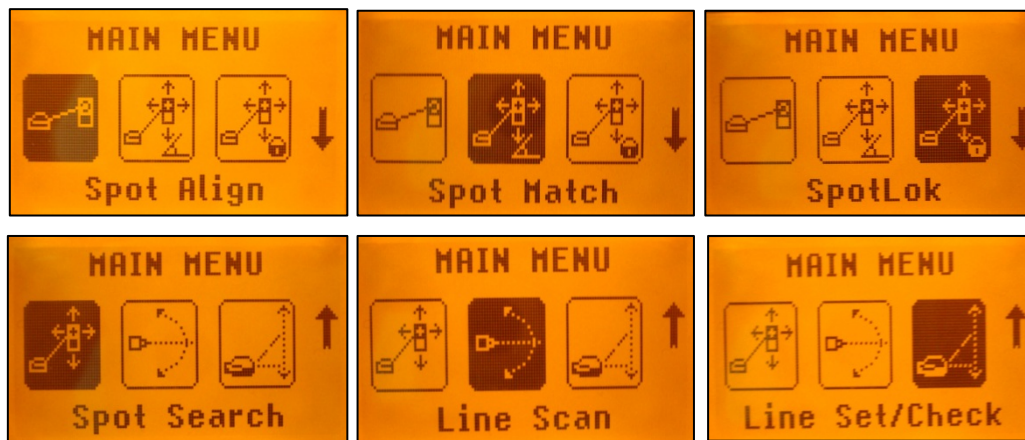

### IR-menu functions available at the DG613



**Entering Grade** – changing the grade value in Step + Go or Digit Select mode.

Press and release the **M** (Menu) button; **Grade Edit** will be highlighted.

Press/release button **E** → The grade value will be shown.

Press/release button **M** → escape/return to the standard display.

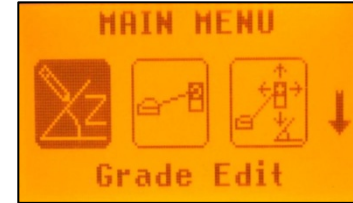

### Step + Go Mode:

Press and hold **(+/-)** buttons for changing the **grade value** after the comma.

Press/release button **2/5** → change the sign of the grade value.

Press and hold **Plus (+)** and **Minus (-)** buttons **simultaneously** starts **Quick change mode** where the grade value in front of the comma will be **set to 0%** and then starts changing **in 1% increments**.

**Note:** When the grade value for the axis reaches its highest amount, the grade value switches to the lowest value for that axis. For example, the value switches from +40% to -12%.

The laser will self-level to the required grade position after confirming the grade change with **E (Enter)** button.

**Note:** The bubble symbol at the laser's and remote's LCD will flash until the laser has been self-leveled to the requested grade position.

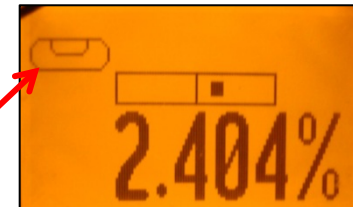
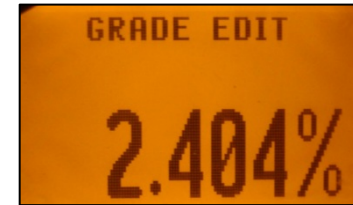

### Digit Select Mode (Default):

A cursor at the sign of the grade value is flashing.

Press and hold the **EL** button → **quick set to 0%**.

Press/release **Plus (+)** and **Minus (-)** buttons → **change the sign** of the grade value.

Pressing and releasing **right** or **left** button moves the **cursor** to the right/left.

Press and release **Plus (+)** and **Minus (-)** buttons to change the selected digit.

The laser will self-level to the required grade position after confirming the grade change with **E (Enter)** button.

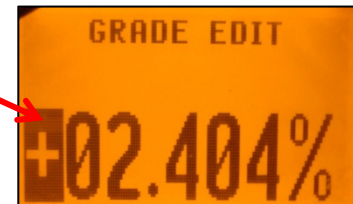

Grade Entering can be exited any time by pressing and releasing **M** button.

**Automatic Spot Align (only DG813)** - The Spot Finder SF803 guides the beam to the target point in the horizontal axis, while the Z-axis grade value will be maintained.

Press and release the **M** button at the standard display and select **Spot Align** using the **(+)/(-)** and **left/right** buttons. Press/release button **M** → escape/return to the standard display. Pressing and releasing **E** button activates the Spot Alignment function. A bubble vial appears while the beam and a Spot Finder symbol will flash.

To make sure the beam moves plumb, adjust the unit until the bubble vial is centered and the beam and SF symbol stop flashing.

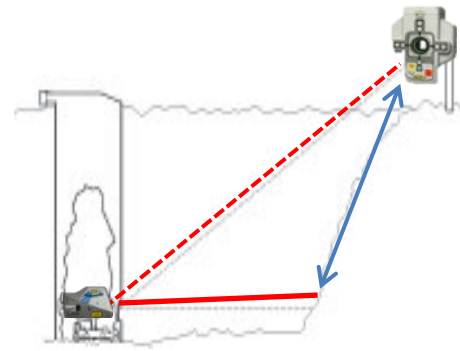

Pressing and releasing **E** button **again** starts the automatic Spot Alignment while the beam becomes a rotating fan beam which will search automatically for the SF803's center position in a range up to +45°.

**Note:** The left SF symbol flashes while an additional SF symbol at the right site of the display indicates the beam movement until the beam is centered at the SF803.

**Note:** The SF803 needs to be tilted into the direction of the DG813 when placed at a steep slope position.

When the alignment is finished, the beam moves plumb down to the dialed in grade value.

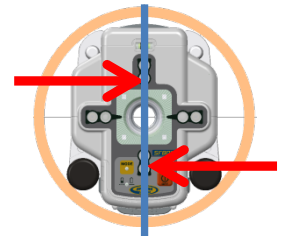

Automatic Spot Align can be exited any time by pressing and releasing **EL** button.



**Automatic Spot Match (only DG813)** - Automatic-Spot-Match can be used for measuring an unknown grade value in an existing pipe or open trench.

Press and release the **M** button at the standard display and select **Spot Match** using the **(+)/(-)** and **left/right** buttons.

Press/release button **M** → escape/return to the standard display.

Pressing and releasing **E** button starts the automatic Spot Match while the beam becomes a rotating fan beam which will be automatically aligned to the SF803's center position.

**Note:** The left SF along with a grade symbol flashes while an additional SF symbol at the right site of the display indicates the beam movement until the beam is centered. When Spot Match has finished, the beam goes through the SF hole and the measured grade value will be displayed.

Automatic Spot Match can be exited any time by pressing and releasing **EL** button.

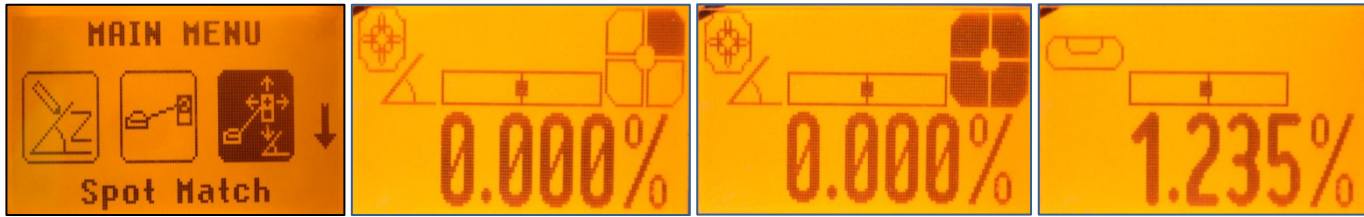
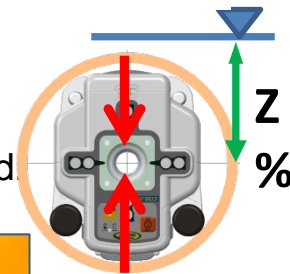
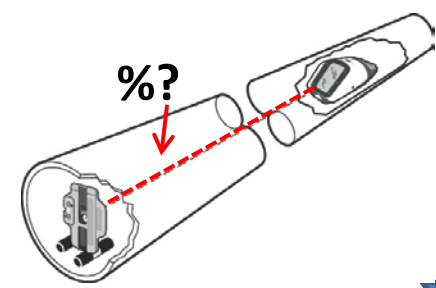

**Automatic SpotLok (only DG813)** - Automatic SpotLok (like PlaneLok) can be used to align and hold the beam automatically to the SF803's center point in automatic or manual mode.

Press and release the **M** button at the standard display and select **SpotLok** using the **(+)/(-)** and **left/right** buttons.

Press/release button **M** → escape/return to the standard display.

Pressing and releasing **E** button starts automatic SpotLok while the beam becomes a rotating fan beam which will be automatically aligned to the SF803's center position.

**Note:** The left SF along with a lock symbol flashes while an additional SF symbol at the right site of the display indicates the beam movement until the beam is centered.

Automatic SpotLok can be exited any time by pressing and releasing **EL** button where the unit switches back to automatic or manual mode.



**Manual Spot Search Mode (only DG813)** - The Spot Search mode is used for pipe laying by detecting the beam manually using the **Spot Finder SF803** and can be activated in **automatic and manual mode**.

Using the “Over the Top” application, the Spot Finder detects the fan beam while the remote control’s display provides the information to position the pipe correctly at the required direction and elevation.

Press and release the **M** button at the standard display and select **Spot Search** using the **(+)/(–)** and **left/right** buttons.

Press/release button **M** → escape/return to the standard display.

Pressing and releasing **E** button starts the manual Spot Search mode while the beam becomes a rotating fan beam.

The empty SF symbol indicates the Spot Search mode has been activated.

A black block at the SF symbol indicates the beam position at the Spot finder and gives the direction for finding the center of the beam. Two black blocks on top or the bottom of the SF symbol confirm the correct direction.

4 black blocks at the SF symbol confirm the Spot Finder has been adjusted to the center of the beam which means the pipe is placed correctly.



Manual Spot Search can be exited any time by pressing and releasing **EL** button.





**Line Scan** - For a faster second day setup, line scan enables complete automatic movement of the laser beam to the left and right limits. Press and release the **M** button at the standard display and select **Line Scan** using the **(+)/(-)** and **left/right** buttons.



Press/release button **M** → escape/return to the standard display.

Pressing and releasing **E** button activates the Line Scan mode while the laser beam moves to the right/left limits of the X- axis and stops at the center position.

When the beam crosses the target press the **EL** button to stop the automatic beam movement.

Corrections for centering the beam at the target can be done using the **left/right** buttons.

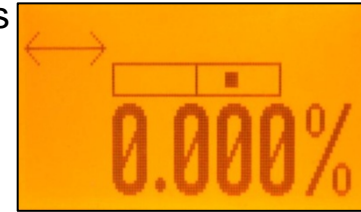
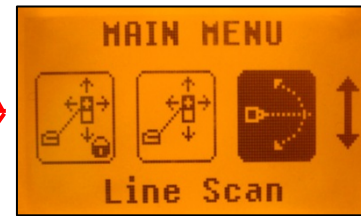

**Line Set/Check** - Moves the laser beam vertically plumb to its maximum limit for setting line in a first day setup without a SF803.

Press and release the **M** button at the standard display and select **Line Set/Check** using the **(+)/(-)** and **left/right** buttons.

Press/release **EL** button → escape/return to the standard display.

Pressing and releasing **E** button activates the Line Set/Check mode while the flashing Line Set/Check symbol  appears together with a bubble vial.

Adjust the bubble vial until it is centered and the Line Set/Check symbol stops flashing.

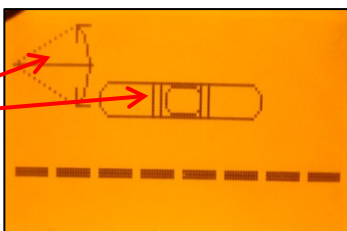
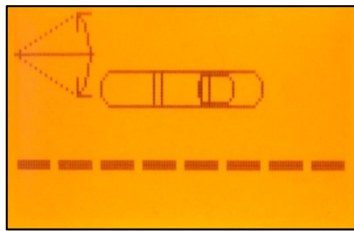
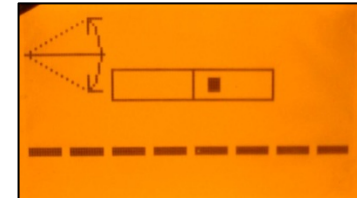
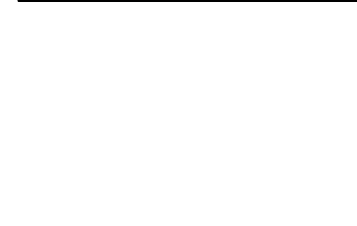

Pressing and releasing the **E** button starts the beam moving automatically up to 45°. Using the **+** or **-** button at the RC803 remote control or at the laser stops the automatic upwards beam movement. Adjust the beam using **Left/Right** buttons until the beam is centered at the line stake. After aligning the beam to the required direction position, pressing and releasing the **EL** button starts the beam plumb down movement to the previous dialed in grade value.

**Start Reference Check** – Before starting some sensitive pipe work, an additional Reference Check can be started manually.

Press and release the **M** button at the standard display and select **Reference Check** using the **(+)/(-)** and **left/right** buttons.

Press/release button **M** → escape/return to the standard display.

Pressing and releasing **E** button starts the Reference Check considering the current temperature inside the housing. While the unit checks the correct 0% reference the beam flashes once a second simultaneously with a thermometer symbol at the display.



**Standby Mode** – activating/deactivating the Standby Mode.

Press and release the **M** button at the standard display and select **Standby** using the **(+)/(-)** and **left/right** buttons.

Press/release **M** button → escape/return to the standard display.

Pressing and releasing **E** button activates the Standby mode.

The self-leveling will be stopped and the beam will be turned off while the Line alert is still active. The display shows the Standby symbol.

To deactivate Standby mode and restore full operation of the laser, press and release **E** button again.



**Settings** – offers the different setting features.  
Please see the Setting Menu details at the following pages.

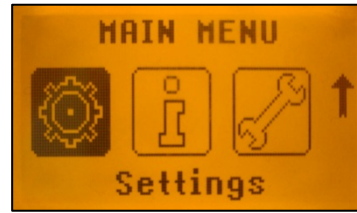

**Info** - The DG/RC information (software version, ID, etc.) or the runtime of the DG will be displayed.

Press and release the **M** button at the standard display and select **Info** using the **(+)/(-)** and **left/right** buttons. Press/release button **M** → escape/return to the standard display. Pressing and releasing **E** button opens the Info's submenu. **Left/Right** buttons can be used to toggle between **About Laser, Runtime** and **Radio**.



Press and release **E** to show the **Laser (Serial number, Software version, internal temperature), Runtime (endless counter) or Radio (actual radio channel)** information.

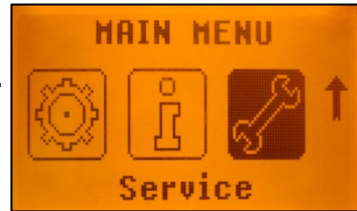

**Service** – ability to recalibrate level sensors.

Press and release the **M** button at the standard display and select **Service** using the **(+)/(-)** and **left/right** buttons.

Press/release button **M** → escape/return to the standard display.

Pressing and releasing **E** button starts the Z-axis calibration process at 0%.

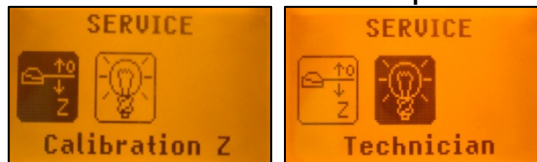

The Service submenu offers also access to special features for technicians only.

**Setting Menu Details** – offers the different setting features.

Press and release the **M** button at the standard display and select **Settings** using the **(+)**/**(-)** and **left/right** buttons.

Press/release **M** button → escape/return to the standard display.

Pressing and releasing **E** button opens the Setting's menu.

**(+) / (-)** and **left/right** buttons can be used to select the desired Setting function then press button **E** to open the selected submenu.

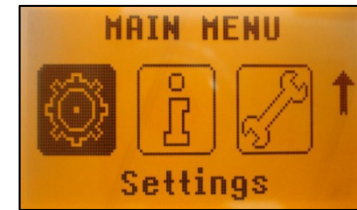

**Grade Entry** – offers selection of Step + Go or Digit Select Mode.

Press and release **left/right** buttons until **Grade Entry** is displayed.

Press/release **M** button → escape/return to the main menu.

Pressing and releasing **E** button opens the submenu. Use the **left/right** buttons to toggle between **Step + Go** and **Digits Select**. (Default).



Press and release **E** to confirm the selection.

**Grade Display** – offers the different Grade Display options.

Press and release **left/right** buttons until **Grade Display** will appear.

Press/release **M** button → escape/return to the main menu.

Pressing and releasing **E** button opens the submenu. **Left/right** buttons can be used to toggle between **Percent** (Default), **Per Mille** and **Degree**.



Press the **E** button to confirm the selection.



**Sensitivity Selection** – offers three different sensitivity options.

Press and release **left/right** buttons until **Sensitivity** is displayed.

Press/release **M** button → escape/return to the main menu.

Pressing and releasing **E** button opens the submenu.

Use the **left/right** buttons to **toggle** between **Low, Mid (Default)** and **High**.



Press the **E** button to confirm the selection.



**Line Alert**– offers three different Line Alert options.

Press and release **(+)/(-)** and **left/right** buttons until **Line Alert** is displayed.

Press/release **M** button → escape/return to the main menu.

Pressing and releasing **E** button opens the submenu.

Use the **left/right** buttons to **toggle** between **LA 5 min, LA 30 sec** and **LA Off**.



Press the **E** button to confirm the selection.

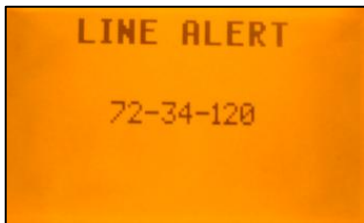

**User Name** – offers the activation of the user name.

Press and release **(+)**/**(-)** and **left/right** buttons until **User Name** is displayed.

Press/release **M** button → escape/return to the main menu.

Pressing and releasing **E** button opens the submenu; cursor flashes.

Use the **EL** button to **toggle** between **both lines**.

Pressing and releasing button **right** or **left** moves the cursor to the right/left.

Press and release buttons **(+)** and **(-)** to change the **character** (letters and numbers).

If the button is held for a longer period of time the speed of changing the characters is increased.

Press the **E** button to store the user name.

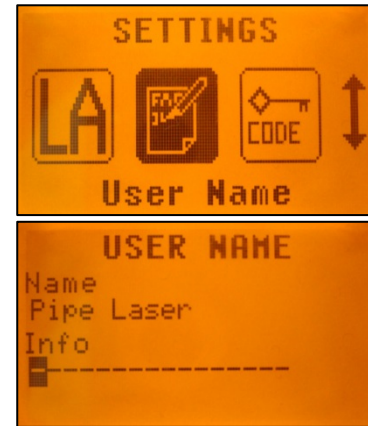

**Set Password** – a password can be entered.

Press and release **(+)**/**(-)** and **left/right** buttons until **Set Password** is displayed.

Press/release **M** button → escape/return to the main menu.

Pressing and releasing **E** button opens the submenu.

Use **button 1 to 6** to type in a password at the second row containing of **4 digits** and repeat the password at the third row.

A previous used password needs to be typed in at the row “Old”.

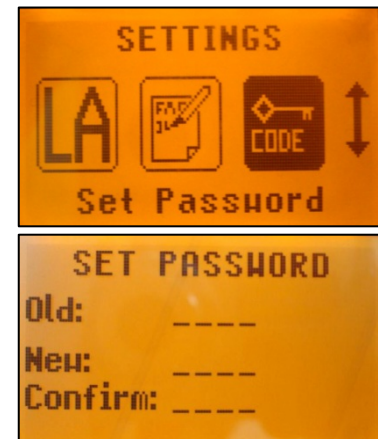
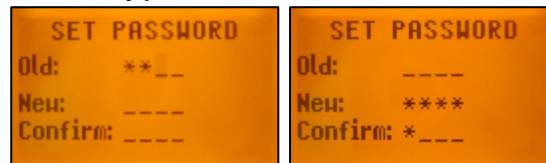

Press and release **E** button to **store the selected password**; unit falls back to the standard display.

**Password ON/OFF** – activating/deactivating Password function.

Press and release **(+)/(-)** and **left/right** buttons until **Password On/Off** is displayed.

Press/release **M** button → escape/return to the main menu.

Pressing and releasing **E** button opens the submenu.

Use the **left/right** buttons to **toggle** between **Password On** and **Password Off**.



Press the **E** button to confirm the selection.

Any time when the DG will be turned on, the password has to be entered after the password function has been confirmed. Typing in a wrong password turns off the DG immediately.

**Radio Channel**– offers the selection of different radio channels.

Press and release **(+)/(-)** and **left/right** buttons **at the Laser** until **RF Channel** is displayed.

Press/release **M** button → escape/return to the main menu.

Pressing and releasing **E** button opens the submenu.

Use the **left/right** buttons to **toggle** between **Channel k1** and **Channel k6**

Press the **E** button to confirm the selection.

After changing the radio channel, the RC803 and SF803 need to be **paired again**.

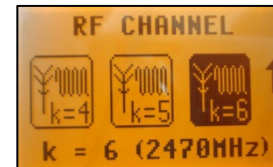
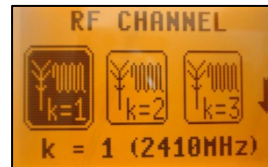



**Select Language** – offers language selection for main menu text.

Press and release **(+)**/**(-)** and **left/right** buttons until **Language** is displayed.

Press/release **M** button → escape/return to the main menu.

Pressing and releasing **E** button opens the submenu.

Use the **(+)**/**(-)** and **left/right** buttons to **toggle** between the different language options.



Press the **E** button to confirm the selection.

**Position Info** – capability of changing transmitters geographical location

Press and release **(+)**/**(-)** and **left/right** buttons until **Position Info** is displayed.

Press/release **M** button → escape/return to the main menu.

Pressing and releasing **E** button opens the submenu; cursor flashes.

Pressing and releasing **right** or **left** button **moves the cursor** to the right/left.

Use the **EL** button to **toggle** between **Latitude** and **Altitude**.

Use the **(+)** and **(-)** buttons for editing the required numbers, then press the **E** button to confirm the dialed in numbers.

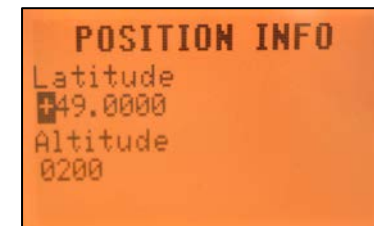

## Troubleshooting DG813/DG613

Any error message can be deleted with a short press of the **E** button. The table shows the related description and possible solutions.

The next service center should be contacted if a different error message as shown at the table will be displayed.

Error codes	Description	Solution
21	Temporary EEprom problem	Repeat pairing and re-enter the customer settings
120	LA alert - Unit setup has been changed	Check laser beam elevation/direction
130	Mechanical Limit during Spot Match - <b>only at DG813</b>	Re-align the closer to the alignment point; check if existing slope is below/above -12% to +40%
140	Laser beam blocked - <b>only at DG813</b>	Make sure there are no obstacles between the transmitter and the SF803
141	Time Out – Automatic alignment or self-leveling could not be completed in the allowed time	Check radio operating range/ connection; ensure a stable laser setup

# Calibration

## Checking Calibration

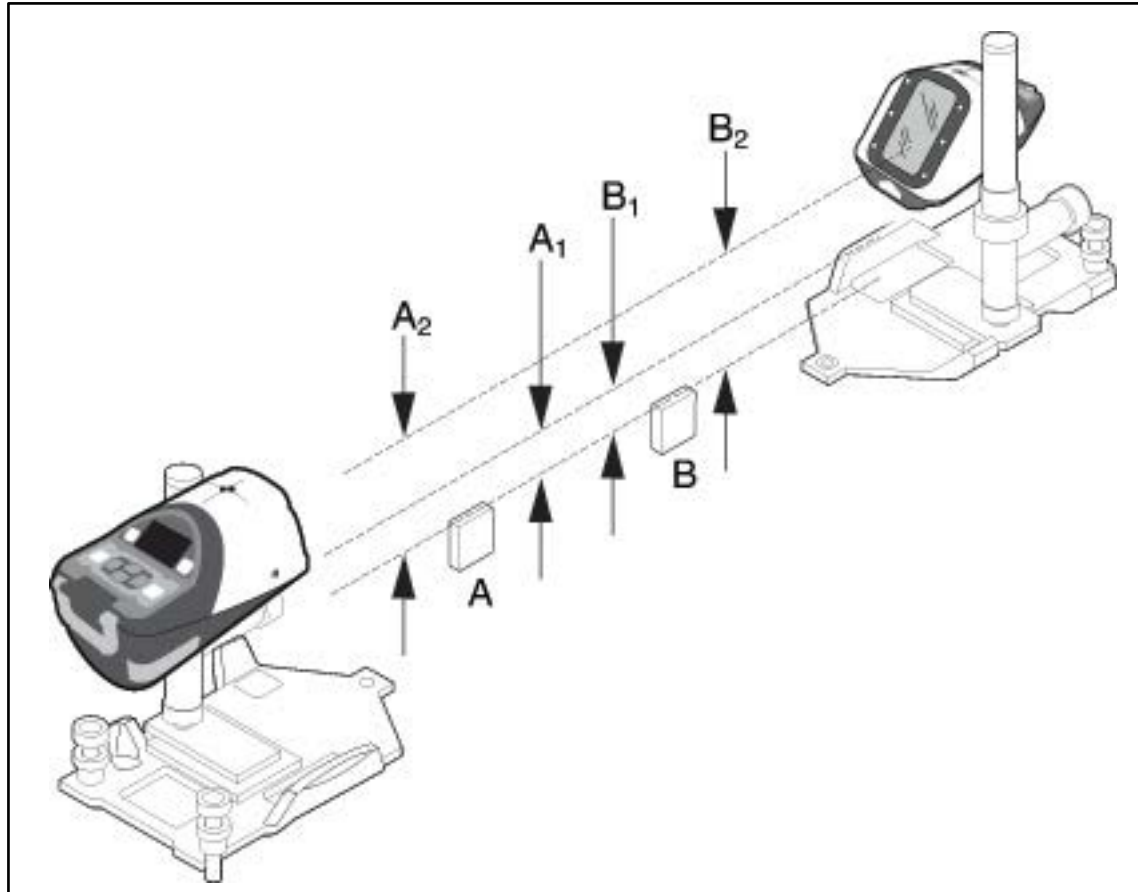

Checking the calibration of your pipe laser is easy. All you need is an engineer's rule and your pipe laser.

1. Select a level road, parking lot or field whose rise is not more than 4 inches in 100 feet (10 cm/30 m).
2. Choose two points (A and B) about 100 feet (30 m) apart. The distance doesn't have to be measured, but the points must be found, so mark them well.
3. Set up the pipe laser just behind the lowest point and rough level.
4. Turn on the pipe laser and let it warm up for about 10 minutes.
5. Set the grade counter to 0.000%.
6. Aim the laser beam so that it passes over points A and B. Allow the pipe laser to self-level.
7. Accurately measure the elevation to the center of the beam at point A and record the elevation as A1 in a table like the one shown below.

	Point A	Point B
Second Reading	A2	B2
First Reading	A1	B1
Difference	A2 - A1	B2 - B1
Error in 100 feet (30 m)	$\frac{(A2 - A1) - (B2 - B1)}{2}$	

8. Accurately measure the elevation to the center of the beam at point B and record the elevation as B1.
9. Move the pipe laser behind point B and aim the laser beam so that it passes over points A and B. Allow the pipe laser to self-level.
10. Accurately measure the elevation to the center of the beam at point B and record the elevation as B2.
11. Accurately measure the elevation to the center of the beam at point A and record the elevation as A2.
12. Subtract the A1 and B1 elevation readings from A2 and B2 elevation readings.

**Note:** *Your laser is in calibration if the difference between  $A2 - A1$  equals  $B2 - B1$ .*

**Note:** *If  $A2 - A1$  is greater than  $B2 - B1$ , the laser beam is shooting high and you should readjust the laser's calibration bringing the beam to level.*

**Note:** *If  $A2 - A1$  is less than  $B2 - B1$ , the laser beam is shooting low and you should readjust the laser's calibration bringing the beam to level.*

**Note:** *If the error is greater than 0.02 feet in 100 feet (6.4 mm/30 m), return the pipe laser to an authorized Trimble service center.*

## Grade Check

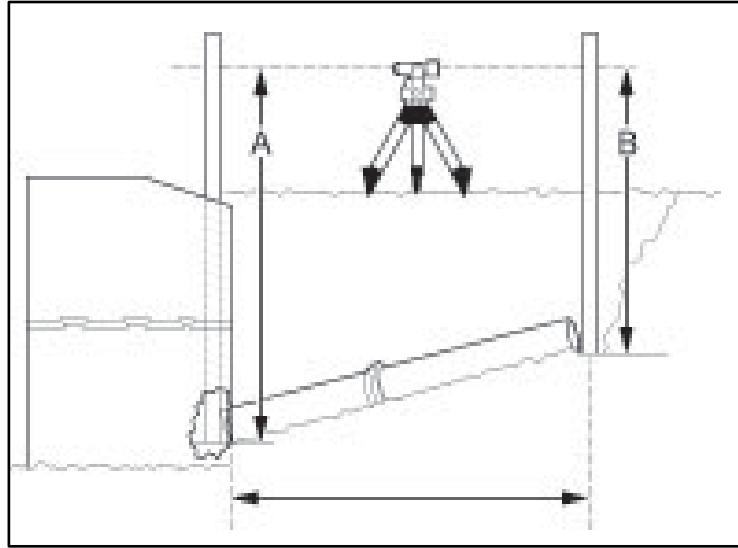

After the first 25 – 50 feet (8 – 15 m) of pipe has been laid, it is recommended that you make a grade check to insure that the setup is correct, and that the system is properly operating.

The illustration shows a method for checking grade.

1. Using a transit level, or an automatic level and a grade rod, take a reading at the beginning of the pipe “A”.
2. Using the same instruments, obtain a level reading at the end of the pipe “B”.
3. The difference between the readings equals the rise over the run.
4. In terms of % of grade, rise divided by the run times 100 equals the percent of grade.

**Note:** *The user of this equipment is expected to follow all operating instructions and make periodic checks on the proper grade, elevation, and line of the pipe as it is being laid. Trimble or its representatives assumes no responsibility for improperly laid pipe.*

**Example:**

	Feet / Tenths	Metric
Rod Reading at "A"	15.74 feet	4.801 m
Rod Reading at "B"	12.289 feet	3.749 m
Rise or Difference (A – B)	3.451 feet	1.052 m
Distance from A to B	145 feet	44.196 m
Rise divided by Run	0.0238	0.0238
Rise divided by Run times 100 = Laser Setting	2.38%	2.38%
Rise according to engineering plans	(2.38% * 145 feet) = 3.451 feet	(2.38% * 44.196 m) = 1.052 m

The pipe is laid correctly when the rod reading "A" minus rod reading "B" equals the rise according to the engineering plans.



## PROTECTING THE UNIT

Do not expose the unit to extreme temperatures or temperature changes (do not leave inside the car). The unit is very robust and can resist damage if dropped even from tripod height. Before continuing your work, always check the leveling accuracy. See **Checking Calibration** section.

The laser is water proof and can be used indoors and outdoors.

## CLEANING AND MAINTENANCE

Dirt and water on the glass parts of laser or prism will influence beam quality and operating range considerably.

Clean with cotton swabs.

Remove dirt on the housing with a lint-free, warm, wet and smooth cloth. Do not use harsh cleansers or solvents.

Allow the unit to air dry after cleaning it.

## PROTECTING THE ENVIRONMENT

The unit, accessories and packaging ought to be recycled.

This manual is made of non-chlorine recycling paper.

All plastic parts are marked for recycling according to material type.



**Do not throw used batteries into the garbage, water or fire. Remove them in compliance with environmental requirements.**

## Notice to Our European Union Customers

For product recycling instructions and more information, please go to:

**[www.trimble.com/environment/summary.html](http://www.trimble.com/environment/summary.html)**

Recycling in Europe: To recycle Trimble WEEE,

Call +31 497 53 2430, and ask for the “WEEE Associate”

Or

Mail a request for recycling instructions to:

Trimble Europe BV

c/o Menlo Worldwide Logistics

Meerheide 45

5521 DZ Eersel, NL



## **Warranty**

Trimble warrants the DG813/DG613 to be free of defects in material and workmanship for a period of five years. Trimble or its authorized service center will repair or replace, at its option, any defective part, or the entire product, for which notice has been given during the warranty period. If required, travel and per diem expenses to and from the place where repairs are made will be charged to the customer at the prevailing rates. Customers should send the product to Trimble Navigation Ltd. or the nearest authorized service center for warranty repairs or exchange, freight prepaid. Any evidence of negligent, abnormal use, accident, or any attempt to repair the product by other than factory-authorized personnel using Trimble certified or recommended parts, automatically voids the warranty. Special precautions have been taken to ensure the calibration of the laser; however, calibration is not covered by this warranty. Maintenance of the calibration is the responsibility of the user.

The foregoing states the entire liability of Trimble regarding the purchase and use of its equipment. Trimble will not be held responsible for any consequential loss or damage of any kind. This warranty is in lieu of all other warranties, except as set forth above, including any implied warranty merchantability of fitness for a particular purpose, are hereby disclaimed. This warranty is in lieu of all other warranties, expressed or implied.

## TECHNICAL DATA

### Laser

Accuracy, Self-Leveling (level)<sup>1,3</sup>:

Operational area<sup>1,2</sup>:

Laser type:

Laser class :

Self-leveling range:

Grade range:

Spot Align search range (DG813):

Line Range:

Leveling indicators:

Power source:

Battery life<sup>1</sup>:

Temperature compensation:

Operating temp.:

Storage temp.:

Tripod attachments:

Dust and Water proof:

Weight:

Low voltage indication:

Low voltage disconnection:

1) at 21° Celsius

2) under optimal atmospheric circumstances

3) along the axis

± 1.5 mm/30 m, 1/16" @ 100 ft, 10 arc seconds  
up to 150 m (500 feet)

red diode laser 600 - 680 nm

Class 3A/3R, <5mW OR class 2

Longitudinal: Over the entire grade range with  
automatic cross axis compensation  
(no rough leveling required);

-12% to +40%

up to +45° (with SF803 tilted to the laser)

20° ±1°

LCD indications; beam and LED flash

10000mAh NiMH battery pack

40 hours NiMH; 50 hours alkaline

Yes

-20°C to 50°C (-4°F to 122°F)

-20°C to 70°C (-4°F to 158°F)

5/8 x 11 horizontally

IP67

3.98 kg (6.61 lbs)

LCD battery indicator

unit shuts off

## TECHNICAL DATA

### Remote Control RC803

Radio operating range (Over the Top) <sup>1,3</sup> :	up to 130 m (425 ft)
IR operating range (front) <sup>1,4</sup> :	up to 150 m (500 ft)
Power source:	2 x 1.5V AA alkaline batteries
Battery life <sup>1</sup> :	130 hours
Dust and Water proof:	IP66
Weight (incl. Batteries):	0.26 kg (0.57 lbs)

### Spot Finder SF803

Operating range <sup>1,4</sup> :	up to 150 m (500 ft)
Power source:	4 x 1.5V AA alkaline batteries
Battery life <sup>1</sup> :	30 hours
Dust and Water proof:	IP67
Weight (incl. Batteries and slider):	0.43 kg (0.95 lbs)

1) at 21° Celsius

3) along the axis

4) depending on WIFI/WLAN ambient environment

## DECLARATION OF CONFORMITY

Please disregard the declaration of conformity within the manual.

Following is the valid declaration:

We

### Trimble Kaiserslautern GmbH

Declare under our sole responsibility that the products

**DG813/DG613 and RC803; SF803**

To which this declaration relates is in conformity with the following directives:

**RoHS 2011/65/EU, R&TTE 1995/5/EC**

**Relevant harmonized standards:**

**EN 60825-1:2014, EN 60950-1:2006 + Amdts, ETSI EN 301 489-01 V1.9.2, ETSI EN 301 489-17 V2.2.1**

The managing director

## **Electro-Magnetic Compatibility**

### **Declaration of Conformity**

This digital apparatus does not exceed the Class B Limits for radio noise for digital apparatus set out in the Radio Interference Regulations of the Canadian Department of Communications.

This device complies with part 15 off the FCC rules. Operation is subject to the condition that this device does not cause harmful interference.

**Note:** The product has been tested and found to comply with the limits for a Class B digital device, pursuant to part 15 of the FCC rules. These limits are designed to provide reasonable protection against harmful interference in a residential installation. The product generates, uses and can radiate radio frequency energy and, if not installed and used in accordance with the instructions, may cause harmful interference to radio or television reception, which can be determined by turning the product off and on. The user is encouraged to try to eliminate the interference by one or more of the following measures:

- Reorient or relocate the receiving antenna.
- Increase the separation between the product and the receiver.
- For more information, consult your dealer or an experienced radio/television technician.

**Caution:** Changes or modifications to the product that are not expressly approved by Trimble could void authority to use the equipment.

# Spectra Precision Laser DG613/DG813

## User Guide

### Contact Information:

#### AMERICAS

**Trimble - Spectra Precision Division**

5475 Kellenburger Road  
Dayton, Ohio 45424 • USA  
Toll Free +1-888-272-2433  
Fax +1-937-245-5489

#### EUROPE, MIDDLE EAST AND AFRICA

**Trimble Kaiserslautern GmbH**

Am Sportplatz 5  
67661 Kaiserslautern • Germany  
Phone +49-6301-711414  
Fax +49-6301-32213

#### ASIA-PACIFIC

**Spectra Precision Division**

80 Marine Parade Road  
#22-06, Parkway Parade  
Singapore 449269 • Singapore  
+65-6348-2212 Phone

[www.spectralasers.com](http://www.spectralasers.com)

© 2015 Trimble Navigation Limited. All rights reserved. Spectra Precision is a Division of Trimble Navigation Limited.  
Spectra Precision and the Spectra Precision logo are trademarks of Trimble Navigation Limited or its subsidiaries. P/N 106831-00 Rev. A

